

★ *Snap-Tite*



QD
Couplings

For hydraulic,
pneumatic &
general purpose
applications

H, JH & PH
SERIES

Designed to MIL-C-51234



★ Snap-Tite **H, IH & PH Series -- Couplings for Hydraulic, Pneumatic and General Purpose Use**

Featuring...Snap-tite quality with built in reliability and flow characteristics over the competition.

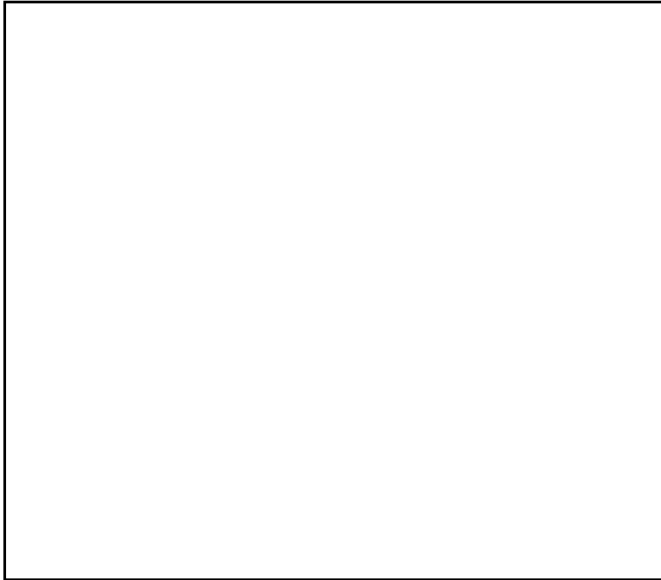

Advantages of H Series

- **Sizes** — 1/8" – 4"
- **Metals** — H Series Quick Disconnect Couplings are available in four metals – steel, brass, aluminum and 316 stainless steel. A variety of protective finishes are available. Please consult factory.
- **Seal Versatility** — Wide choice of standard and special seal materials enable the H, IH & PH series to handle a great variety of fluids.
- **Sleeve Lock** — Sleeve lock option aids in preventing accidental disconnection of the coupling. To disconnect, align the pin in the body with the slot in the sleeve and retract sleeve.

- **(Valve & Valve) Quick Disconnect Low Pressure Drop** — The two-piece body construction permits larger flow passages than the designated size of the coupling, permitting greater flow while maintaining low pressure drop and provides end fitting versatility.
- **Smooth Flow** — Snap-tite's "Jet Stream" valve design helps maintain a clean linear flow. Positive positioning of the valve aids in maintaining a steady, even flow under normal working conditions.
- **Flow on Connection** — Valves are designed to automatically open in both the coupler and nipple halves when the unit is connected permitting maximum free flow.
- **Shut-off On Disconnection** — Valves are designed to automatically close under normal usage conditions in both the coupler and nipple halves when the unit is disconnected.
- **Fast Efficient Operation** — Connect or disconnect in seconds. To connect, pull back the sleeve, insert the nipple into the coupler and release the sleeve. To disconnect, pull back the sleeve, remove the nipple and the halves are disconnected.
- **Dependable Operation** — Ball-lock mechanism provides positive connection. Hardened stainless steel balls along with a radiused and induction hardened (steel) ball race gives extended life to the H Series couplings.
- **Positive Sealing Connected** — O-ring and Teflon back-up ring provide for positive sealing across a wide range of applications. This sealing configuration allows use of the latest elastomeric compounds for those tough media and environments.
- **Positive Sealing Disconnected** — The metal to metal contact of the valve with the coupler or nipple body is designed to control compression of the valve seal eliminating wear and increasing seal life.

H Series quick disconnects have been proven by years of use on hydraulic-pneumatic applications and in handling of many gases and fluids. The H Series fully engineered design meets or exceeds MIL-C-51234 and provides superior flow characteristics with built in reliability.

PH Option — Has the same advantages built into the H Series with the addition of an instant, automatic bleed-off valve built into the valve for fast, easy connection of hydraulic lines and for other applications that call for periodic connection against trapped static hydraulic pressure. The PH option can be placed in either the valve coupler or the valve nipple and are completely interchangeable with the H Series coupler or nipple.

The PH option has successfully been field tested in connecting against static pressures up to 3,000 psi (210 bar). Available in steel, Trivalent plated, in sizes 3/8", 1/2", 3/4" and 1".

IH Option — The IH Series is identical to the H Series except for the valve which was designed specifically for durability when used in pneumatic systems using reciprocating, pulsating and rotary motion air tools. Cylindrical construction of the IH valve provides 360° contact with the plain H Series nipple. This permits repeated cycling while enabling efficient operation and long life. Available in steel, Trivalent plated in sizes 1/4", 3/8", 1/2" and 3/4".

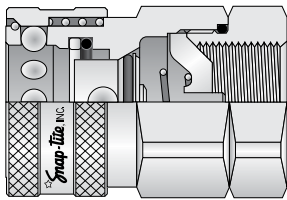

IH Option

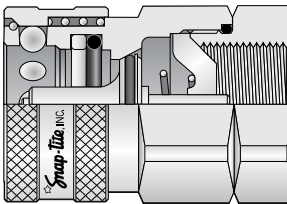

PH Option

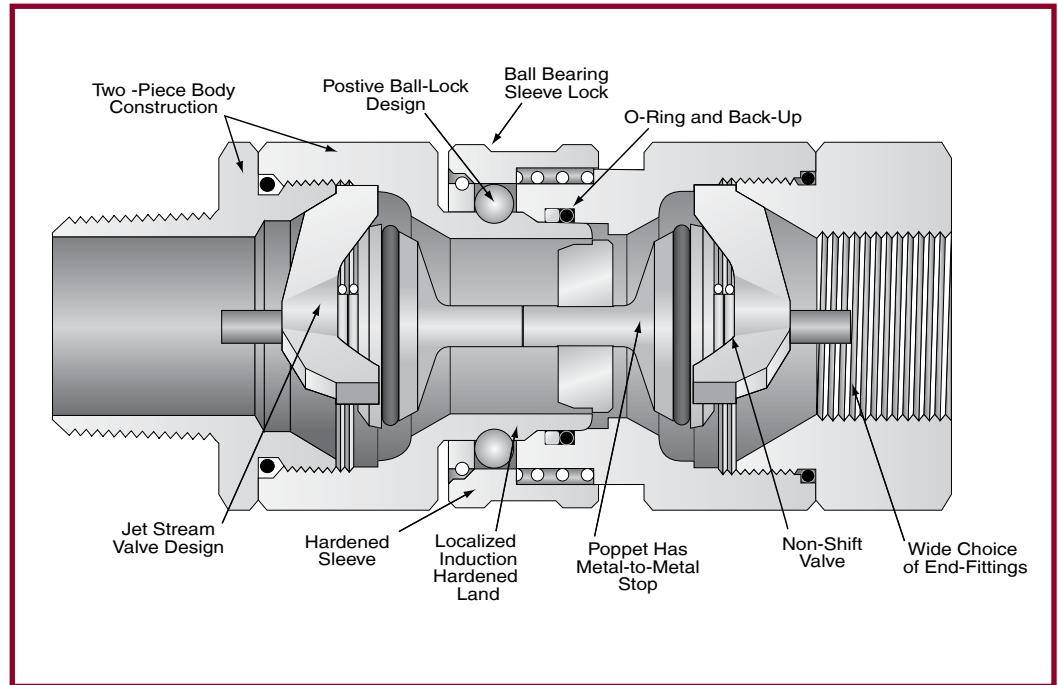

WORKING PRESSURES

Quick Disconnect Size	Valve & Valve (Double Shut-off) Valve & Plain (Single Shut-off)								Plain & Plain (No Shut-off)							
	Steel		Aluminum		Brass		Stainless Steel		Steel		Aluminum		Brass		Stainless Steel	
	psi	bar	psi	bar	psi	bar	psi	bar	psi	bar	psi	bar	psi	bar	psi	bar
1/4"	6500	448	2250	155	2250	155	5000	345	11000	759	4000	276	4000	276	10000	690
3/8"	4500	310	2250	155	2250	155	4000	276	11000	759	4000	276	4000	276	8000	552
1/2"	4000	276	1750	121	2000	138	3750	259	11000	759	4000	276	4000	276	8000	552
3/4"	3500	241	1750	121	2000	138	2000	138	9000	621	3500	241	3500	241	7000	483
1"	2000	138	1500	103	1750	121	2000	138	6000	414	3000	207	3000	207	4000	276
1-1/4"	1750	121	375	26	350	24	1500	103	5000	345	1000	69	1000	69	3000	207
1-1/2"	1500	103	375	26	350	24	1500	103	5000	345	1000	69	1000	69	3000	207
2"	1500	103	300	21	400	28	500	34	4000	276	750	52	750	52	1000	69
2-1/2"	1000	69	300	21	400	28	400	28	1000	69	300	21	400	28	400	28
3"	750	52	200	14	200	14	400	28	750	52	200	14	200	14	400	28
4"	500	34	150	10	150	10	300	21	500	34	150	10	150	10	300	21

NOTE: Pressure ratings were established under static pressure conditions. Therefore, pressure ratings for any given flow, pressure surge, and/or vibration may vary from these ratings.

Pressure and Flow Data

Pressure ratings of standard quick disconnects can be increased for some applications by slight design modifications or if specific operating conditions are met. On applications requiring higher ratings than those listed or pressure surges, please consult the factory. Burst pressures listed were taken at the point at which failure rendered the quick disconnect inoperative. (Proof pressure equals 1-1/2 times the working pressure; burst pressure equals 2 times working pressure.)

H SERIES

Valved and Valved (Double Shut-off)
FLOW RATE (LPM)

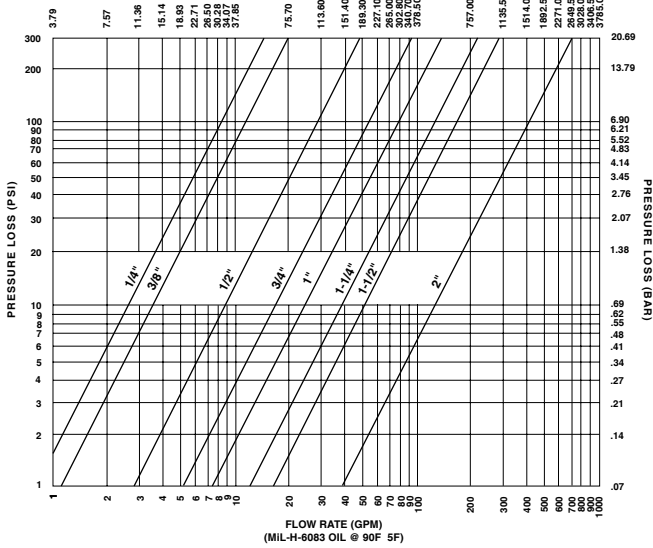

Valved and Plain (Single Shut-off)
FLOW RATE (LPM)

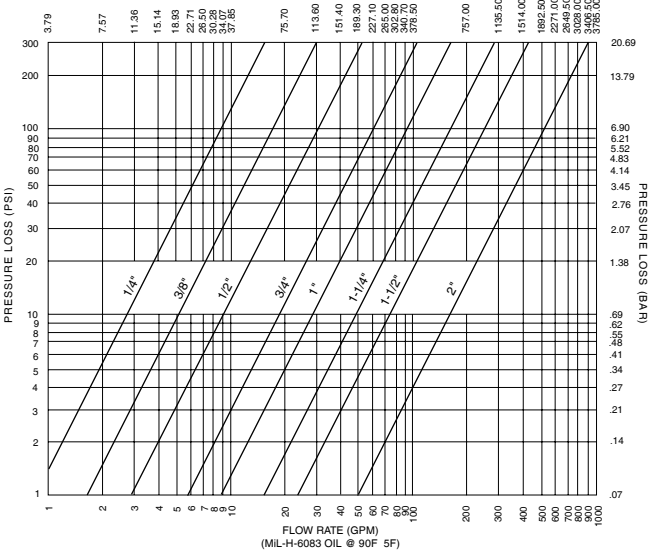

IH SERIES

CFM FREE AIR AT 17.7 PSIA, 70F

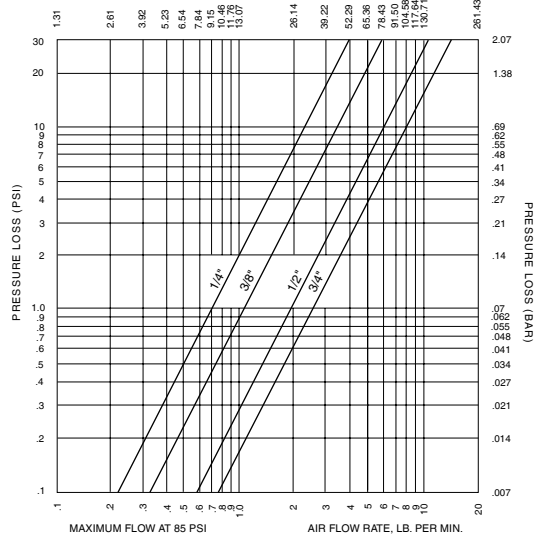

PH SERIES

Valved and Valved (Double Shut-off)
FLOW RATE (LPM)

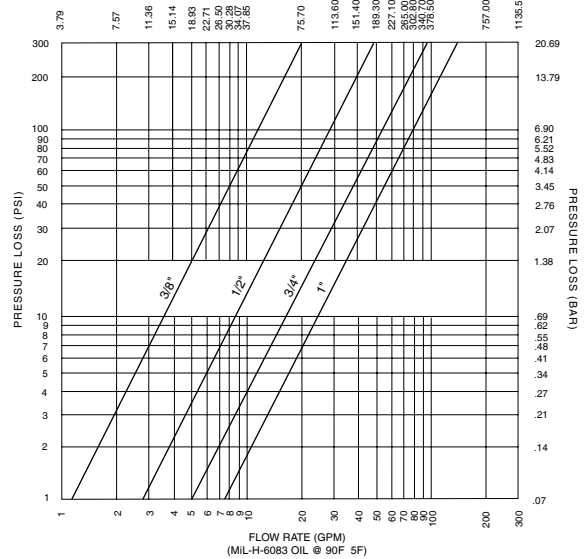

COUPLING COMBINATIONS & END FITTINGS

1. Double shut-off coupling: Valve coupler and valve nipple
 2. Single shut-off coupling: Valve coupler and plain nipple
 3. No shut-off or straight through: Plain coupler and plain nipple. Plain couplers cannot be used with valve nipples.
- All combinations of the same size are interchangeable regardless of material, finish or end fittings.

VALVE

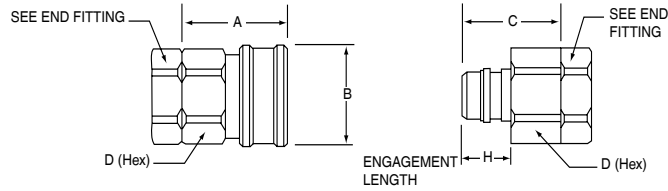

Size		1/4"	3/8"	1/2"	3/4"	1"	1-1/4"	1-1/2"	2"	2-1/2"	3"	4"
A	in	1.34	1.50	1.62	1.92	2.07	2.28	2.57	3.14	3.63	3.88	4.58
	mm	34.04	38.10	41.15	48.77	52.58	57.91	65.28	79.76	92.20	98.55	116.33
B	in	1.19	1.39	1.63	2.00	2.19	2.75	3.50	4.50	5.45	6.75	1.00
	mm	25.40	30.23	35.31	41.40	50.80	55.63	69.85	88.90	114.30	138.13	171.45
C	in	1.28	1.44	1.51	1.79	1.95	2.15	2.41	2.94	3.42	3.79	4.47
	mm	32.51	36.58	38.35	45.47	49.53	54.61	61.21	74.68	86.87	96.27	113.54
D²	in	.88	1.00	1.19	1.50	1.88	2.00	2.75	3.75	4.50	4.75	6.75
	mm	22.35	25.40	30.23	38.10	47.75	50.80	69.85	95.25	114.30	120.65	171.45
H	in	.58	.71	.72	.88	.91	.90	1.06	1.32	1.41	1.56	1.93
	mm	14.73	18.03	18.29	22.35	23.11	22.86	26.92	33.53	35.81	39.62	49.02

END FITTINGS¹

		Size	1/4"	3/8"	1/2"	3/4"	1"	1-1/4"	1-1/2"	2"	2-1/2"	3"	4"
Male Tapered Pipe 	F	in	.75	.69	.95	.96	1.14	1.31	1.44	1.40	1.83	1.88	2.88
		mm	19.05	17.53	24.13	24.38	28.96	33.27	36.58	35.56	46.48	47.75	73.15
	G²	in	.88	1.00	1.19	1.50	1.88	2.00	2.50	3.50 ³	4.00	4.75	6.00
		mm	22.35	25.40	30.23	38.10	47.75	50.80	63.50	88.90 ³	101.60	120.65	152.40
EM Male SAE Flared and MS33656 	F	in	.74	.74	.84	1.13	1.16	1.27	1.46	1.71			
		mm	18.80	18.80	21.34	28.70	29.46	32.26	37.08	43.43			
	G²	in	.88	1.00	1.19	1.50	1.88	2.00	2.50	3.50 ³			
		mm	22.35	33.27	30.23	38.10	47.75	50.80	63.50	88.90 ³			
MS33657 	F	in	1.23	1.31	1.47	1.84	1.84	1.95					
		mm	31.31	33.27	37.34	46.74	46.74	49.53					
	G²	in	.88	1.00	1.19	1.50	1.88	2.00					
		mm	22.35	25.40	30.23	38.10	47.75	50.80					
Female Tapered Pipe 	F	in	.31	.40	.47	.50	.60	1.26	.70	.78	.90	.88	1.13
		mm	7.87	10.16	11.94	12.70	15.24	32.00	17.78	19.81	22.86	22.35	28.70
	G²	in	.88	1.00	1.19	1.50	1.88	2.00	2.50	3.50	4.00	4.75	6.00
		mm	22.35	25.40	30.23	38.10	47.75	50.80	63.50	88.90	101.60	120.65	152.40
EF Female Straight and MS33649 	F	in	.46	.70	.57	1.00	.87	1.11	.85	1.01			
		mm	11.68	17.78	14.48	25.40	22.10	28.19	21.59	25.65			
	G²	in	.88	1.00	1.19	1.50	1.88	2.00	2.50	3.50			
		mm	22.35	25.40	30.23	38.10	47.75	50.80	63.50	88.90			
EB Male SAE Bulk-Head 	F	in	1.39	1.56	1.67	2.03	1.84	2.14					
		mm	35.30	39.62	42.42	51.56	46.74	54.36					
	G²	in	.88	1.00	1.19	1.50	1.88	2.00					
		mm	22.35	25.40	30.23	38.10	47.75	50.80					
Female RP⁴ British Parallel 	F	in	.39	.40	.53	.56	.60	1.26	.70	.78	.90	.88	1.13
		mm	9.91	10.16	13.46	14.22	15.24	32.00	17.78	19.81	22.86	22.35	28.70
	G²	in	.88	1.00	1.19	1.50	1.88	2.00	2.50	3.50	4.00	4.75	6.00
		mm	22.35	25.40	30.23	38.10	47.75	50.80	63.50	88.90	101.60	120.65	152.40

PLAIN FEMALE PIPE

PLAIN FEMALE RP⁴

PLAIN MALE PIPE

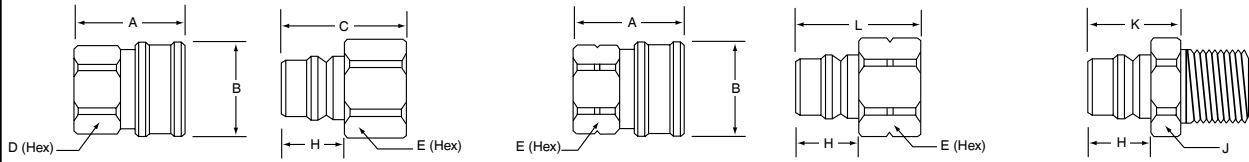

Size		1/4"	3/8"	1/2"	3/4"	1"	1-1/4"	1-1/2"	2"	2-1/2"	3"	4"
A	in	1.34	1.50	1.62	1.91	2.07	2.28	2.57	2.48	3.11	3.35	3.88
	mm	34.04	38.10	41.15	48.51	52.58	57.91	65.28	62.99	78.99	85.09	98.55
B	in	1.00	1.19	1.39	1.63	2.00	2.19	2.75	3.50	4.50	5.45	6.75
	mm	25.40	30.23	35.31	41.40	50.80	55.63	69.85	88.90	114.30	138.43	171.45
C	in	1.32	1.52	1.72	1.92	2.10	2.22	2.44	2.60	2.95	3.40	3.73
	mm	33.53	38.61	43.69	48.77	53.34	56.39	61.98	66.04	74.93	86.36	94.74
D²	in	.88	1.00	1.19	1.50	1.88	2.00	2.50	3.25	3.75	4.75	5.50
	mm	22.35	25.40	30.23	38.10	47.75	50.80	63.50	82.55	95.25	120.65	139.70
E^{2,4}	in	.63	.81	1.00	1.19	1.50	1.88	2.13	2.75	3.25	4.00	5.00
	mm	16.00	20.57	25.40	30.23	38.10	47.75	54.10	69.85	82.55	101.60	127.00
H	in	.58	.71	.72	.88	.91	.90	1.06	1.32	1.41	1.56	1.93
	mm	14.73	18.03	18.29	22.35	23.11	22.86	26.92	33.53	35.81	39.62	49.02
K	in	.78	.98	1.01	1.14	1.16	1.17	1.34	2.03	2.08	2.59	2.58
	mm	19.81	24.89	25.65	28.96	29.46	29.72	34.04	51.56	52.83	65.79	65.53
J²	in	.56	.69	.88	1.06	1.38	1.88	2.13	2.50	3.25	4.00	5.00
	mm	14.22	17.53	22.35	26.92	35.05	47.75	54.10	63.50	82.55	101.60	127.00
L	in	1.27	1.44	1.72	1.86	2.13	2.22	2.44	2.60	2.95	3.40	3.73
	mm	32.26	36.58	43.69	47.24	54.10	56.39	61.98	66.04	74.93	86.36	94.74

NOTES:

- *1 Other special end fittings available upon request
- *2 Dimensions taken across the hex flats. Round stock with two milled flats may be substituted for hex stock. Dimensions across flats same as dimensions across hex flats. Max O.D. of round stock will not exceed the dimensions across the points of the hex stock. Valve coupler and nipple bodies may be supplied from round bar stock without wrench flats.
- *3 3.5" (88.9 mm) across hex flats - may substitute 3.75" (95.25 mm) round with 3.38" (85.85 mm) across wrench flats.
- *4 Notch on Hex indicates RP British parallel threads.

ACCESSORIES

Dust caps, dust plugs and pressure caps protect disconnected coupler and nipple from damage, dirt and other contaminants. Dust caps and dust plugs are available in plastic and clear anodized aluminum.



Plastic Dust Cap
PDCP

Plastic Cap/Plug

Inexpensive means to protect your investment against contamination and damage. Comes with a loop to fit over pipe fitting or affixing to equipment with sheet metal screw. Available in sizes 1/4" thru 1". Plastic Cap/Plug design can be used on either a nipple or coupler.



Metal Dust Plug
AMPH Metal Dust Cap
ADCH

Aluminum Dust Caps and Plugs

Alternate method to protect your equipment - aluminum dust caps and plugs are available in sizes 1/4" thru 3". The 1/4" thru 3/4" sizes come with 10" chrome plated brass bead chain. The 1" and above come with steel zinc plated sash chain.



Metal Pressure Cap
MCH

Pressure Caps

Pressure-tight pressure caps for nipples are standard in steel, Trivalent plated. Other materials such as brass, aluminum and stainless steel available on special order. Sizes available 1/4" thru 3". Sizes 1/4" thru 3/4" come with 10" length of corrosion resistant steel cable. Sizes 1" thru 3" come with 12" of cable-all with adjustable loop at end of cable. Consult factory for special lengths and part number.

SIZES	PLASTIC CAP/PLUG	ALUMINUM PLUG	ALUMINUM CAP	PRESSURE CAP
1/4"	PDCP-4	AMPH-4	ADCH-4	MCH-4
3/8"	PDCP-6	AMPH-6	ADCH-6	MCH-6
1/2"	PDCP-8	AMPH-8	ADCH-8	MCH-8
3/4"	PDCP-12	AMPH-12	ADCH-12	MCH-12
1"	PDCP-16	AMPH-16	ADCH-16	MCH-16
1-1/4"		AMPH-20	ADCH-20	MCH-20
1-1/2"		AMPH-24	ADCH-24	MCH-24
2"		AMPH-32	ADCH-32	MCH-32
2-1/2"		AMPH-40	ADCH-40	MCH-40
3"		AMPH-48	ADCH-48	MCH-48

HOW TO ORDER

Part No.	S	V	H	C	4-4	F	OPTIONS		
Material No letter Steel, plated A Aluminum clear anodized B Brass S Stainless Steel 316	Body Type V Valve P Plain (without valve)	Series H PH¹ IH²	Coupling Half C Coupler N Nipple	Coupling Size 4 = 1/4" 6 = 3/8" 8 = 1/2" 12 = 3/4" 16 = 1" 20 = 1-1/4" 24 = 1-1/2" 32 = 2" 40 = 2-1/2" 48 = 3" 64 = 4"	End Fitting Size 2 = 1/8" 4 = 1/4" 6 = 3/8" 8 = 1/2" 10 = 5/8" 12 = 3/4" 16 = 1" 20 = 1-1/4" 24 = 1-1/2" 32 = 2" 40 = 2-1/2" 48 = 3" 64 = 4"	End Fitting Type (see page 5) M Male NPT F Female NPTF ³ EF Female SAE EM Male SAE 37° Flare EB Bulkhead SAE RP Female British Parallel BS2779 49 MS33649 Female 56 MS33656 37° Male Flare 57 MS33657 Bulkhead 14 MS33514 Male 15 MS33515 Bulkhead	Seal Material No letter for Buna N (Code A) JF Military variation of Buna N for hydrocarbon fuels M Military variation of Buna N for MIL-H-5606 fluids V Viton® E Ethylene propylene rubber	Sleeve Lock SL Aids in preventing accidental disconnection. To disconnect, align the pin in the body with the slot in the sleeve.	

¹ PH Valve option recommended on one side, not both. Available in steel only.

² IH available in steel only.

³ For sizes up to 1" NPTF threads in steel.
 For sizes up to 1" NPSF threads in stainless steel.
 For sizes over 1" NPT threads.

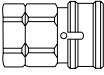

SPARE PARTS

Snap-tite Quick Disconnect Couplings are designed for long, trouble-free life. Upon occasion, certain parts may get damaged and need to be ordered.

Valve Kits (Includes valve, valve spring and stop. Valve seal is included in sizes 3/8" thru 1" in steel, brass and aluminum only).

Part Number – Use the base part number followed by SPK **Example:** VHC4-SPK
 VIHC6-SPK

Valve Seals (1/4" valve seal is staked in the coupler and nipple bodies in all materials and is not considered field repairable. 3/8" and above are available for repair).

Part Number – "H (size)-55 (seal material)" **Example:** H6-55A*
 H8-55A*

Nipple Seals (Includes O-ring and back-up ring located in coupler half)

Part Number "H (size)-56-9 (seal material)". **Example:** H6-56-9A*
 For "old style" U Packer design use designation "H (size)-56 (seal material)". **Example:** H6-56A*

When ordering Nipple Seals, determine if you have the standard design or the old style U-Packer design by comparing the product to the cutaways shown below:

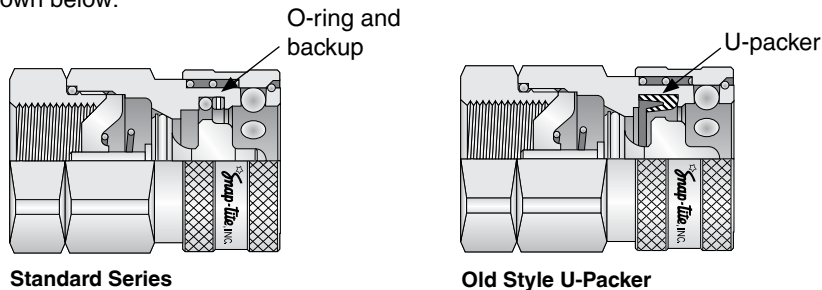

*"A" required for Buna-N Seal Kits. All others use seal material code shown above.
 For other available spare parts, consult factory.

! WARNING !

FAILURE OR IMPROPER SELECTION OR IMPROPER USE OF THE PRODUCTS AND/OR SYSTEMS DESCRIBED HEREIN OR RELATED ITEMS CAN CAUSE DEATH, PERSONAL INJURY AND PROPERTY DAMAGE.

This document and other information from Snap-tite, Inc., its subsidiaries and authorized distributors provide product and/or system options for further investigation by users having technical expertise. It is important that you analyze all aspects of your application and review the information concerning the product or system in the current product catalog. Due to the variety of operation conditions and applications for these products or systems, the user, through its own analysis and testing, is solely responsible for making the final selection of the products and systems and assuring that all performance, safety and warning requirements of the application are met.

The products described herein, including without limitation, product features, specifications, designs, availability and pricing, are subject to change by Snap-tite, Inc. and its subsidiaries at any time without notice.



Quick Disconnect & Valve Division

201 Titusville Road
Union City, Pennsylvania 16438-8699 USA
PH: 814-438-3821 FAX: 814-438-3069
e-mail: qd&v_sales@snap-tite.com
www.snap-tite.com

01-0005BE-0608



Industrial Estate
Whitemill - Wexford
Republic of Ireland
PH: 353 53 914 1566 FAX: 353 53 914 1582
e-mail: ste_sales@snap-tite.com
www.snap-tite.com

DISTRIBUTED BY:

ISO-9001 Certified